

The LC Connector with a 1,25mm ceramic ferrule and a snap (push-pull) coupling, is the most used SFF (Small Form Factor) connector in today's telecom and datacom networks.

Novobit is an official licensed LC manufacturer and meets international standards IEC 61754-20 / TIA 604-10 and RoHS/REACH compliant. All LC assemblies are compliant to performance standards IEC-61753, IEC 61754-4, IEC 61755-3-1.

It can be assembled with cables from  $\varnothing 0.6\text{mm}$  up to  $\varnothing 3.0\text{mm}$ . The Novobit LC connector-kit meet category E for extreme environment and may be used between  $-40$  and  $+85^{\circ}\text{C}$ , and is available as simplex or duplex with clip (patchcord) or without clip (pigtail).

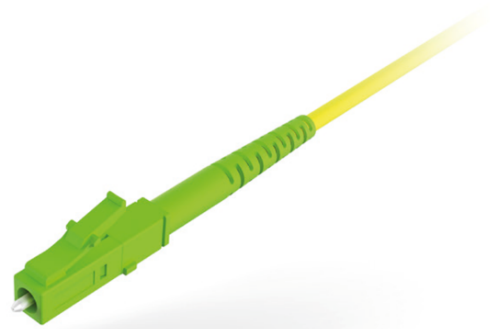

Assembly Specifications		Single-mode		Multi-mode
Performance Class		Grade B	Grade C	Grade M
IL max. against reference [dB]		0.15	0.35	0.35
IL typical against reference [dB]		0.06	0.12	0.20
Return Loss [dB]	PC	$\geq 45$	$\geq 45$	$\geq 27$
	UPC	$\geq 55$	$\geq 55$	$\geq 30$
	APC	$\geq 65$	$\geq 65$	-
Fiber Height [nm]	PC	-50 to +50	-50 to +100	-50 to +100
	APC	-50 to +50	-100 to +100	-
Apex Offset [ $\mu\text{m}$ ]		$\leq 50$	$\leq 50$	$\leq 50$
Radius [mm]	PC	5 to 25	5 to 25	5 to 25
	APC	5 to 12	5 to 12	-
Angle (°) of APC		$8 \pm 0.4$	$8 \pm 0.4$	-
Tensile Strength [N]		$> 100$	$> 100$	$> 100$

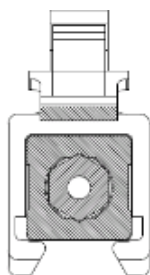

### Novobit 30-degree step tuning

The ferrule can be positioned into 12 different positions offering  $30^{\circ}$  step tuning. This unique patented process and product enables Novobit to supply grade A connectors.

# LC Connectors & Adapters

Connector Specification	
<b>Housing</b>	Plastic; blue, green, beige customized colors on request
<b>Ferrule Diameter</b>	Zircona D: 1.25mm d: 125.3-126.3µm
<b>Concentricity</b>	≤1.0µm (SM); ≤4.0µm (MM)
<b>Tuning</b>	30 degree steps
<b>Cable Diameter</b>	0.6 - 3mm
<b>Flammability</b>	UL 94 V-0
<b>Humidity</b>	95 %
<b>Durability</b>	≥1000 Matings
<b>Tensile Strength</b>	70N
<b>RoHS/REACH</b>	Compliant

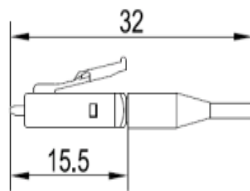
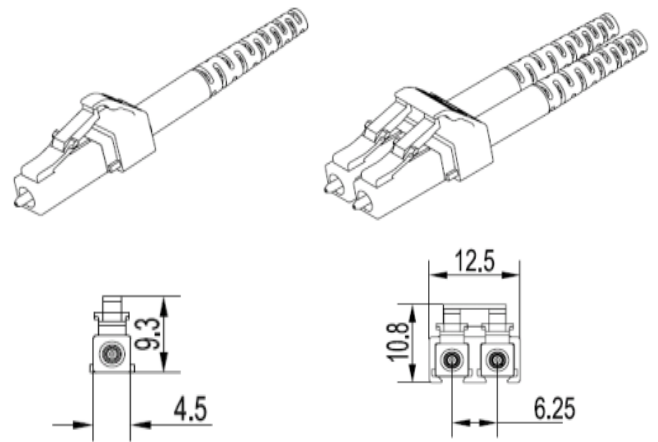

Pigtail

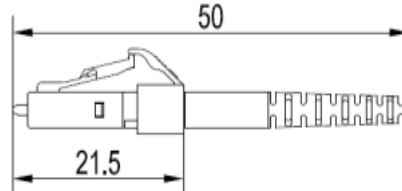

Patchcord

Adapter Specifications:	
<b>Attenuation</b>	< 0,2 dB
<b>Repeatability 1000 cycles</b>	< 0.2 dB
<b>Service life</b>	> 1000
<b>Temperature</b>	-40 °C to +85 °C
<b>Flammability</b>	UL 94 V-0
<b>Humidity</b>	95 %
<b>Sleeve material</b>	Zirconia
<b>RoHS/REACH</b>	Compliant

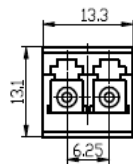
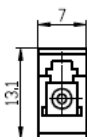
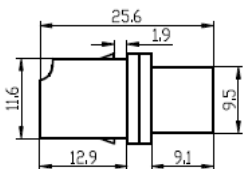

Simplex

Duplex

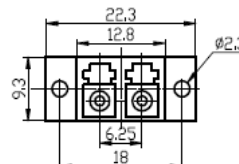
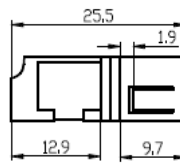

Duplex SC-type

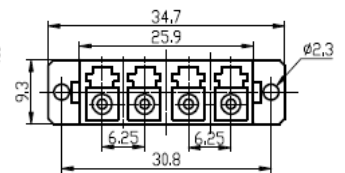

Quad SC-type